

7830S

Concerto

The 7830S Concerto fills the need in today's office for flat panel display support that can adapt to a wide variety of configurations and applications. The economical triple screen with dual monitor arms give the user the ability to quickly find the ultimate ergonomic position for the flat panel display at an affordable price.

7800 series

Features & Benefits

Flexibility and more options for the end user with a simple, easy-to-use Allen wrench adjustment

The Concerto supports a 20 lbs load capacity (per screen)

The arm swivels 360° around the base, increasing the options for display position

Options are available for panel, wall and slatwall mounting configurations

Desk clamp and grommet mount hardware are included to minimize SKUs

Clamp and grommet adjustable to fit most desks and work surfaces

Monitor mounting bracket, with Quick Connect, contains 75mm and 100mm hole patterns to comply with VESA standards

Allows for a maximum 18" screen width

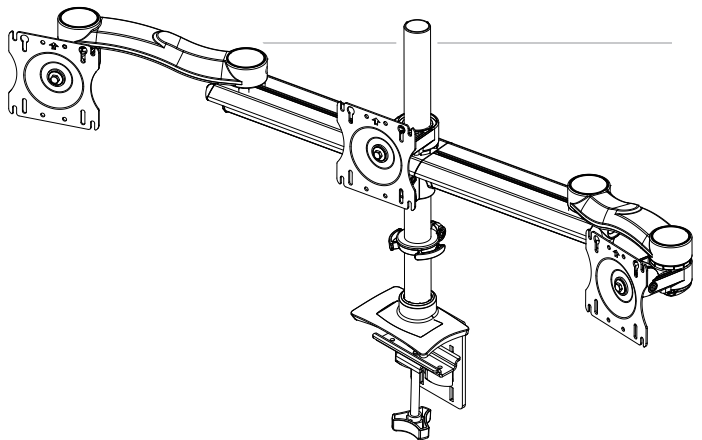
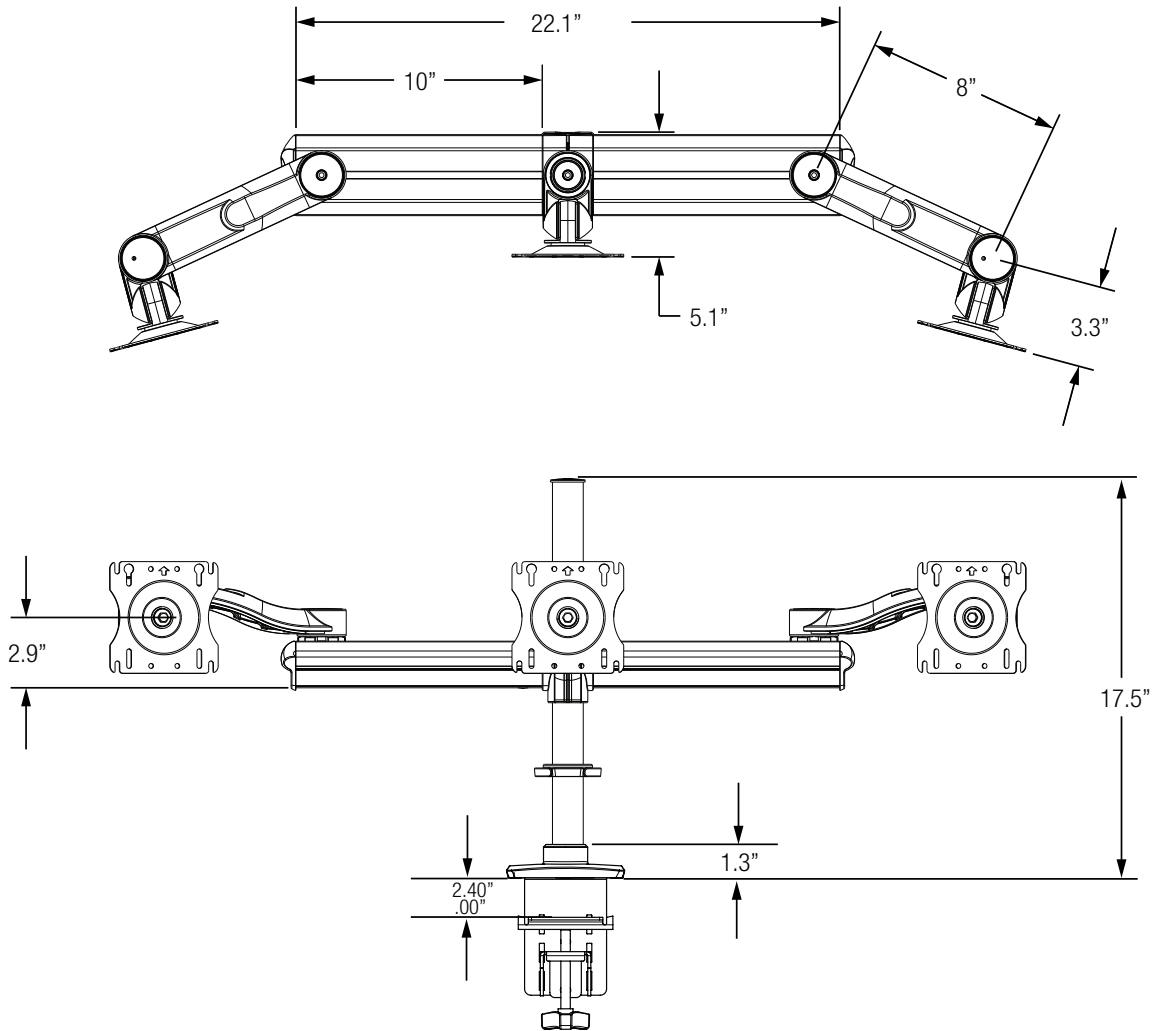

Concerto Beam Mount 7800 series

Model	Description
7830S	Triple-Screen, two Single Extension arms, one Pole-Mounted on beam

Colour Options

To specify colour, other than silver, replace the "S" in the part number with:

B = Black **W** = White

For example, to get a "7830S" in white, order 7830W.



Note: Specifications are subject to change without notice.



2700 Oak Industrial Dr. NE
 Grand Rapids, MI 49505-6026 USA
 1.800.253.1561 | 616.459.3311
 Fax: 877.636.3290
www.kv.com

This and other KV literature is available for download at www.kv.com > Resource Library

Knap & Vogt reserves the right to change product specifications at any time without notice and without incurring responsibility for existing units.
 ©2016 Knap & Vogt. KV and the KV logo are trademarks of Knap & Vogt.