



Allegretto™ Height Adjustable Table Frame Kits

Features

A 26" height adjustment range allows users to alternate between seated and standing positions, thereby reducing backaches, pains, stress, tension, and improves blood circulation.

A low 58 dB noise level ensures that the operation of the table does not inconvenience others in the office environment.

A standard 'C' leg configuration increases under table space giving customers the option of customizing their tables even further with an ergonomic keyboard tray helping create a complete ergonomic solution.

With a 1.6 in/s height adjustment speed, tables can quickly be adjusted from one height to another in a short period of time.

The table motors only use a combined 0.06W of standby power when not in use thus lowering the total cost of ownership for end users.

Every Allegretto™ kit is shipped flat packed and is expandable with hinged legs that snap into position for easy assembly. Final assembly takes less than 30 minutes to complete.

The table frame kits can easily be adjusted to fit different table top widths (48"-96") making purchasing much easier for the customer.

Customers only need to order one part number as all the required components for the table frame kit are in one box.

Exceeding most industry standards, the table frame has been designed and tested to support up to 264 lbs.

To improve end user safety the leg motors have Anti-Collision protection that will stop and reverse the travel of the table when the table collides with a fixed object during operation.

The Allegretto™ has been designed to provide a contemporary modern design feel to any office environment.

5 Year Mechanical and 2 Year Electrical Warranty.

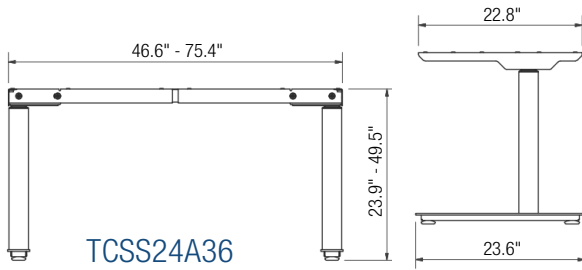
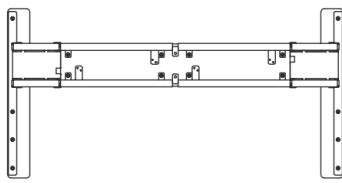

TCSS24A36

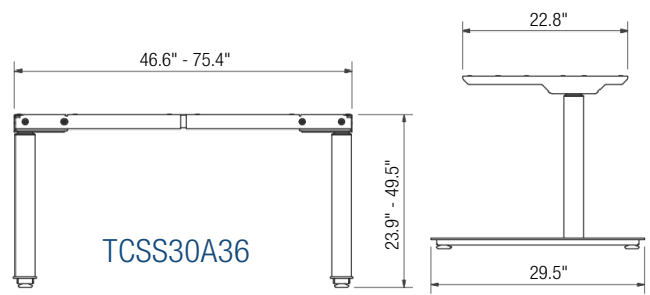
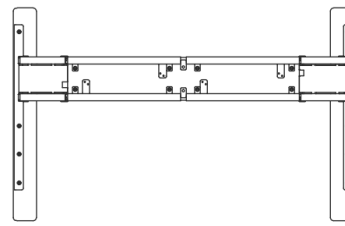

TCSS30A36

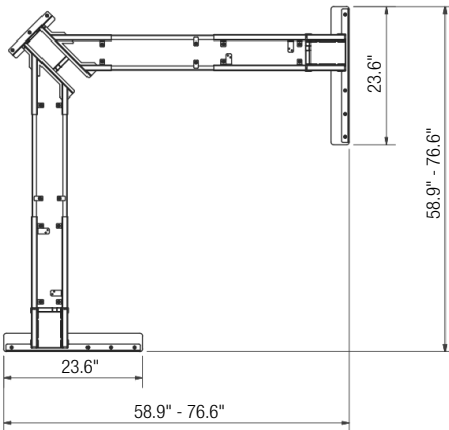

TCLS24A36

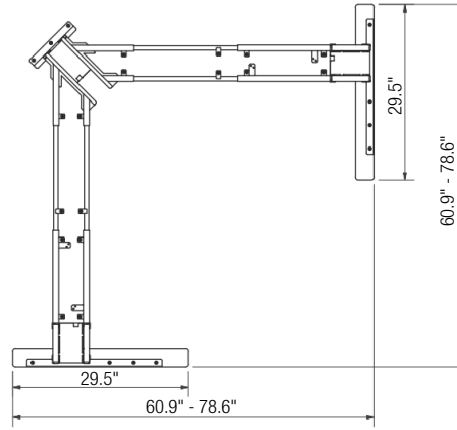

TCLS30A36



Allegretto™ Height Adjustable Table Frame Kits

Ancillary Products:

- Use with Knape & Vogt Waterloo CPU holders
- For keyboard trays, specify the Tenor™ & Staccato keyboard trays
- For flat panel displays, specify the Concerto flat panel support system

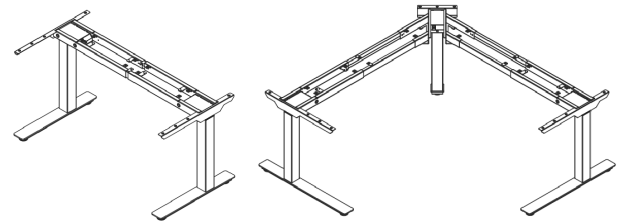

Model	Leg Orientation	Table Configurations Number of Legs	Foot Size	Telescopic Stages	Height Adjustment Control	Weight	Box Dimensions
TCSS24A36*	C	Rectangular - 2 legs	24"	3	Four Memory/Six Button Programmable	82 lbs.	49" L x 9" W x 12" H
TCLS24A36*	C	'L' Shaped - 3 legs	24"	3	Four Memory/Six Button Programmable	117 lbs.	57" L x 10" W x 12" H
TCSS30A36*	C	Rectangular - 2 legs	30"	3	Four Memory/Six Button Programmable	82 lbs.	49" L x 9" W x 12" H
TCLS30A36*	C	'L' Shaped - 3 legs	30"	3	Four Memory/Six Button Programmable	117 lbs.	57" L x 10" W x 12" H

To specify color, replace the "*" in part number with: **B** = Black **S** = Silver
For example, to get a TCLS30A36 in Black, order TCLS30A36B.

Notes: 1. Weight = packaged shipping weight per unit. 2. Specifications are subject to change without notice.



2700 Oak Industrial Dr. NE
Grand Rapids, MI 49505-6026 USA
1.800.253.1561 | 616.459.3311
Fax: 877.636.3290
www.kv.com

This and other KV literature is available for download at www.kv.com > Resource Library

Knape & Vogt reserves the right to change product specifications at any time without notice and without incurring responsibility for existing units.
©2016 Knape & Vogt. KV and the KV logo are trademarks of Knape & Vogt.